

X|Clear Quick Start Guide

Revision 1.1



1 INSTALLATION GUIDELINES

- The X Stream Designs enclosure system should be installed by qualified personnel.
- The X|Clear enclosure system has an integrated X|Smart power supply and controller with integrated 4 Port 10/100Mbps network switch and requires an IP address. Contact your network administrator for an appropriate IP address prior to installing the system on your network.
- This unit must not be used for medical, life saving purposes, or for any purpose where its failure could cause serious injury or the loss of life.
- This unit must not be used in any way where its function or failure could cause significant loss or property damage.

Security Notes
While the system runs a security firewall, the X|Smart™ system employs a Linux operating system and does have the ability to support features such as telnet, FTP and SSH. For this reason, there is a chance the system can be compromised allowing access to other devices on your local network. As with any device installed on a network, appropriate security precautions should be observed.

If the X|Smart™ system is installed on a network accessible from the Internet, it is recommended to use an appropriate password to access the web user interface. Passwords should be at least 8 characters in length and use a combination of upper and lower case letters and numbers. For additional security, a firewall may be used to limit access to the enclosure system from selected IP addresses and IP Subnets.

Final X|Smart™ Installation Notes
The X|Smart™ product and the integrated 4 port network switch supports 10/100Mbps network connections. Port 1 provides IEEE 802.3at PoE+ while Port 4 provides 24VDC Passive PoE allowing you to power most wireless radios. Both PoE ports are remotely controllable via the enclosures web GUI.

SPECIAL CARE ITEMS

Please Pay Special Attention to the Following:
The X| Model enclosures are electro-mechanical devices that require basic knowledge of electronics and mechanical mechanisms for safe use. Please take special note to the following preventive measures.

- Wires, Cables, Accessory Hardware Must Be Neatly Organized And Bundled To Not Interfere With The Mechanical Rotating Dome Assembly (X|Rain & X|Clear Models).
- The Pathway Between The Housing And Door Must Be Free From Obstruction And Interference From Accessory Items And Cables When Closing The Housing.
- Closing And Latching The Housing Requires Careful Alignment Of The Housing And Door To Ensure The Proper Seal Between The Two Mating Surfaces.
- A Secure Fit Between The Enclosure And Mounting Bracket Must Be Obtained When Mounting The Enclosure. Failure To Ensure Proper Engagement Between The Mounting Bracket And Enclosure May Result In The Enclosure Disengaging From The Mount And Falling To The Ground.
- Keep Hands And Fingers Away From Operating Fans And The Rotating Dome Assembly Mechanism.

2 SAFETY

Electrical Connection, Power Supply & Electronic Components:

- Power Consumption Must Not Exceed The Power Supply Max Current Output (Reference Power Tables in the User Manual).
- Wires, Cables, Accessory Hardware Must Be Neatly Organized And Bundled To Not Interfere With The Mechanical Rotating Dome Assembly (X|Rain™ & X|Clear™ Models).
- The Pathway Between The Housing And Door Must Be Free From Obstruction And Interference From Accessory Items And Cables When Closing The Housing.
- A Qualified And Licensed Electrician Must Make All Electrical Connections In Compliance With All Codes. Installation Of The Camera Should Be Made By A Qualified Installer.
- The Power Supply Chassis Should Not Be Removed From The Unit. There Is A Serious Risk Of Injury From Electric Shock Due To Exposed Electrical And Electronic Components Contained Within The Power Supply Chassis.
- Tampering With Any Of The Electrical Components Can Cause Damage And Pose A Serious Risk Of Injury From Electric Shock.
- Keep Hands And Fingers Away From Operating Fans And Rotating Dome Assembly Mechanism.
- Power Accessory Ports Are Identified With Output Voltage And Polarity. The Installer Must Proceed With Caution And Care To Ensure That The Electrical Connections Are Connected Properly With The Correct Polarity And Voltage.
- Some Enclosure Models Have A Source Of Heat Located On The Rear Side Of The 90-Degree Leg Of The Power Supply Chassis. The Heat System Is Comprised Of A Flexible Silicon Pad Adhered To The Rear Side Of The Power Supply Chassis. Care Should Be Taken To Avoid Touching This Area To Eliminate The Possibility Of A Burn.
- There Are Two Fans Located Within The Power Supply Chassis. Care Must Be Taken Not To Obstruct These Fans With Cabling Or Cable Ties.

3 HANDLING & CARE

Opening & Closing the Unit

- Housing To Door Alignment** - To obtain proper seal when closing and latching the enclosure, all mating surfaces must be aligned, and all internal components including cabling and cable ties must be clear of any opposing surfaces between the door and housing to ensure that the door will close securely without interference. To align the mating surfaces of the housing and door, lift housing from lower right hand corner applying a slight upward force while closing the housing door. All surfaces should be evenly matched around the two mating surfaces before attempting to latch the latches. Caution: do not attempt to close the enclosure without the four (4) ¼ -20 mounting bolts securely fastened to the mounting bracket. Without these bolts in place, the enclosure may slip off of the mounting bracket and fall to the ground.
- Latches and Latching Force** - Once all surfaces are aligned, engage the latches and apply a light force to secure the latches. These latches are designed to pull the two sections of the enclosure together which provides the necessary pressure on the seal between the two sections. Caution: Do not force the latches to close. If they feel tight, re-align the housing surfaces and apply a slight closing force to the housing and engage the latches.
- Potential Cable Pinch Points & Improper Sealing** - Prior to closing the housing door, all cables and accessory hardware must be securely fastened within the enclosure and stowed to prevent interference between the two housing sections prior to closing.

Mounting the Enclosure to a Structure

- The X| series of enclosures are designed to mount specifically to the X Stream Designs mounting bracket. Do not attempt to substitute the X Stream Designs mounting bracket with another brand. Doing so will void the product warranty and pose a serious safety risk and damage to the product.
- A secure fit between the enclosure and mounting bracket must be obtained when mounting the enclosure. Failure to ensure proper engagement between the mounting bracket and enclosure may result in the enclosure disengaging from the mount and falling to the ground.

4 BOX CONTENTS

- X|Clear Enclosure System
- This Quick Start Guide
- Wall Mount Bracket (Figure A)
- Camera Mounting Plate (Figure B)
- Camera & Enclosure Mounting Hardware (Figure C)
- Corrugated Camera Assembly Nest [2]

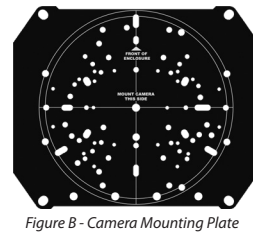
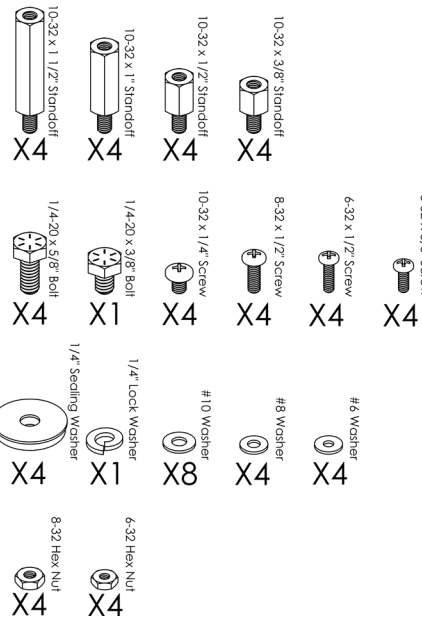
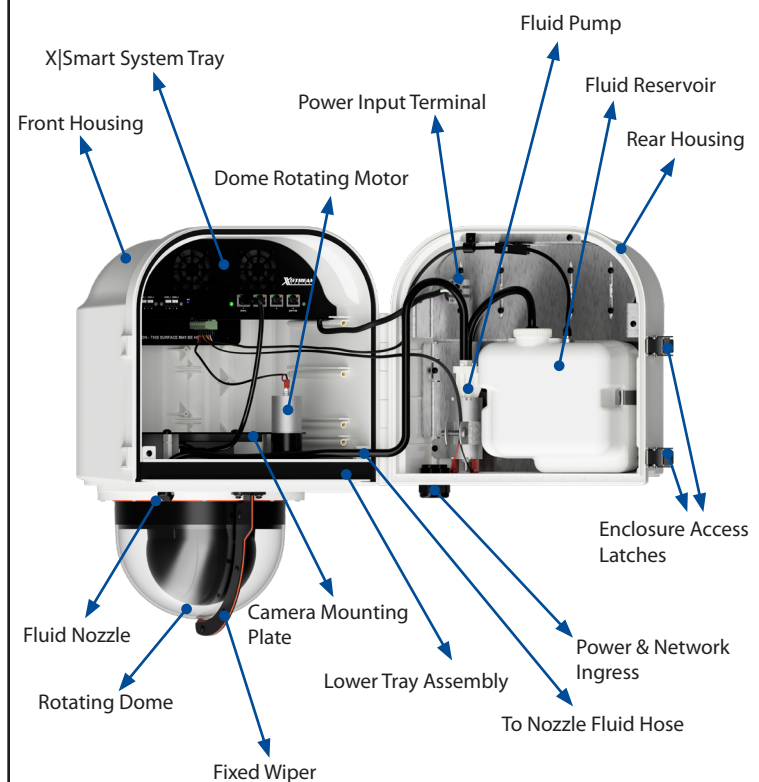

Figure C - Camera & Enclosure Mounting Hardware

5 GETTING TO KNOW THE ENCLOSURE



6 QUICK START GUIDE

This Quick Start Guide with guide you through the initial set-up process of your enclosure system. For complete system setup instructions, please access our online user manuals at:

XSD PTZ User Manual: http://xstreamdesigns.com/downloads/XSD_PTZ_UserManual.pdf
X|Smart Software Manual: http://xstreamdesigns.com/downloads/XSD_XSmartManual.pdf

- Open the Box
- Remove the Accessories Box
- Remove the Top Assembly Nest
- Remove the Foam Filler Packaging
- Place the Top Assembly Nest on a Flat Surface
- Remove the Camera Enclosure from the Box & Clear Packaging Bag
- Carefully Lay the Enclosure on its Side with the Door Latches Facing Up
- Unlatch the Door Latches and Open the Enclosure
- Remove the Lower Tray and Dome Assembly

- With a phillips screwdriver, loosen and remove the two screws holding the lower tray assembly. (Figure 1 - Red Arrows)
- Next, disconnect the power leads from the dome rotating motor. (Figure 2)
- While applying a slight pulling pressure to widen the housing (Figure 3), carefully slide the lower tray assembly out of the camera housing. The lower tray assembly will still be attached to the back housing by the 1/4" black PVC tubing that connects to the fluid pump. Use caution not to tug on the fluid hose as it can cause future leaks in the plumbing.



Figure 1 - Removing lower tray fastening screws.

Figure 3 - Removing the lower tray assembly.

7

- Slide the Assembly Nest close to the enclosure system as shown in Figure 4. Place the Lower Tray & Dome Assembly into the the Assembly Nest. Ensure that the wiper is positioned to rest in the cut-out of the nest assembly as shown.



Figure 4 - Assembly Nest.

- Mounting the Camera to the Universal Mounting Plate

(A) Remove the Camera Mounting Plate (Figure 5), Camera Mounting Screws Kit (Figure 6a), and Camera Mounting Standoffs Kit (Figure 6b) from the accessory box.



Figure 6a - Camera Mounting Screws Kit



Figure 6b - Camera Mounting Standoffs Kit

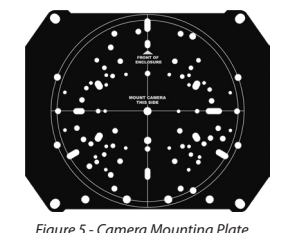

Figure 5 - Camera Mounting Plate

8

(B) Position camera mounting hardware onto the camera mounting plate and align in the center using the outer circles as reference. (Figure 7). If the holes do not line up in order to center the camera, you will have to center the camera plate, mark and drill your own holes.

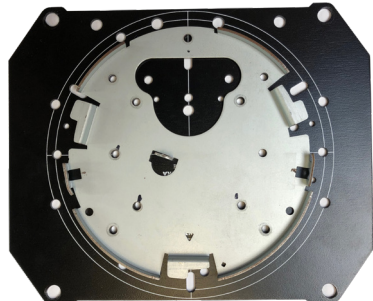

Figure 7 - Positioning camera mounting hardware.

(C) Attach the camera mounting hardware to the camera mounting plate using the supplied screws. (Figure 8)



Figure 8 - Attaching camera mounting hardware.

9

(D) Attach the camera to the camera mounting plate and measure the height as show in Figure 9.



Figure 9 - Measuring the height of camera assembly.

(E) The included camera mounting hardware consists of [4] - 3/8", [4] - 1/2", [4] - 1", and [4] - 1 1/2" Hex Standoffs. Figure 10 below gives you the possible heights and the necessary size standoffs to reach those heights.

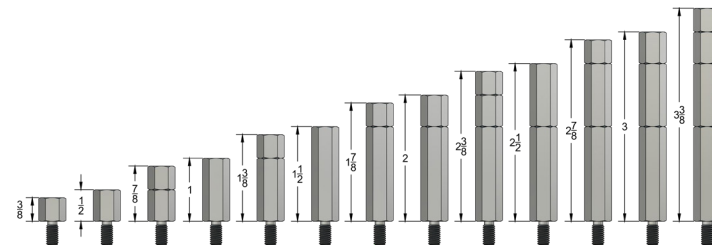

Figure 10 - Possible Standoff Height Increments

10

(F) To determine a height for the camera mounting standoffs, we need to do a little math. Figure 11 below will help you visualize what we are trying to achieve. The depth of the dome lens from the standoff mounting point is 6.1 inches. We want to mount the camera so that it sits 1/4 inch above the bottom of the dome lens. Using the following formula, we can determine the proper height for the standoffs.

$$\text{Standoffs Height} = [\text{Camera Height}] - [6.1 \text{ Inches (Dome Depth)}] + [1/4 \text{ Inch (Height Above Bottom of Dome)}]$$

Example :
Camera Height as Determined in Step (D) = 8.3 Inches
Standoffs Height = 8.3 Inches - 6.1 Inches + .25 Inches
Ideal Standoffs Height = 2.45 Inches

Referring to Figure 10, you'll find that you can make either 2 3/8 (2.375) or 2 1/2 (2.5) inch heights. To keep a minimum of 1/4 inch above the bottom of the dome, round up to 2.5 inches and assemble 1 1/2 inch and 1 inch standoffs together to create 4 standoffs with a height of 2.5 inches.

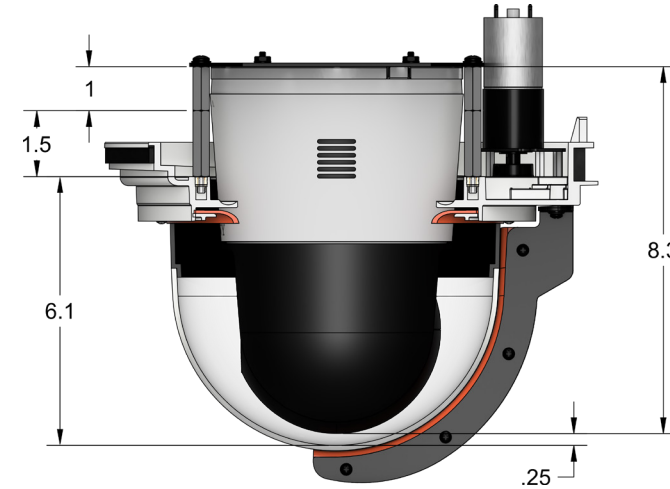

Figure 11 - Camera Mounting Dimensions

11

(G) Take the assembled standoffs with the correct heights and screw them into the four locations depicted by red arrows in Figure 12 below. Make sure they thread in properly and use a 3/8" wrench or adjustable wrench to carefully secure the standoffs into place. Caution - Little force is required. You are screwing the standoffs into metal inserts which are melted into the polycarbonate. To much force will break the metal inserts from the housing.



Figure 12 - Securing the standoffs into the lower tray assembly.

(H) Carefully lower the camera assembly onto the standoffs as shown in Figure 13 below ensuring that the camera head does not contact the dome surface. Holding the camera assembly in place on the standoffs, lift the lower tray from the assembly nest to verify its height above the bottom of the dome is approximately .25 inches. If the height is off, either your measurements or math were not accurate. Use taller or shorter standoff combinations to adjust the camera assembly height to the desired .25 inches above the bottom of the dome. Secure the camera assembly to the standoffs using the [4] - 10-32 x 1/4" screws and [4] - #10 flat washers as shown in Figure 14 below.



Figure 13 - Lowering camera assembly onto the standoffs.



Figure 14 - Securing camera mount assembly to the standoffs.

12

(I) Referencing Step 9 and Figures 1, 2 and 3, reverse the steps to remove the lower tray and slide the Lower Tray & Camera Assembly back into the housing and secure in place with the same two screws removed (6-32 x 3/8"). When hooking up the power leads to the dome rotating motor, make sure they are secure and the polarity is correct by connecting the black wire to the lead with a [-] next to it.

12. Mount the enclosure mounting bracket to the mounting surface ensuring that it is level - both side to side and front to back.

13. Slide the enclosure onto the mounting bracket as shown in Figure 15 ensuring positive engagement. The enclosure will sit on the mounting bracket without holding it. However, holding pressure down on top of the enclosure above the mounting bracket to ensure it does not fall off the mounting bracket in the next few steps is good practice.



Figure 15 - Lowering enclosure onto wall mount bracket

13

14. Carefully open the enclosure and remove the fluid reservoir to expose the back of the rear housing (Figure 16). From within the enclosure, insert and tighten [4] 1/4-20 bolts with stainless & silicone washers (Figure 17) through the rear housing (see red arrows) into the wall mount bracket (Figure 18)

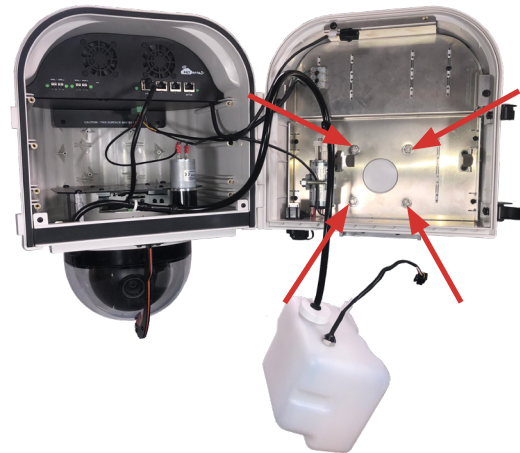

Figure 16 - Securing the Enclosure to the wall mount bracket



Figure 17 - Enclosure mounting bolts.
[4] 1/4-20 x 3/4" Bolts with Washers



Figure 18 - Wall mount bracket.

14

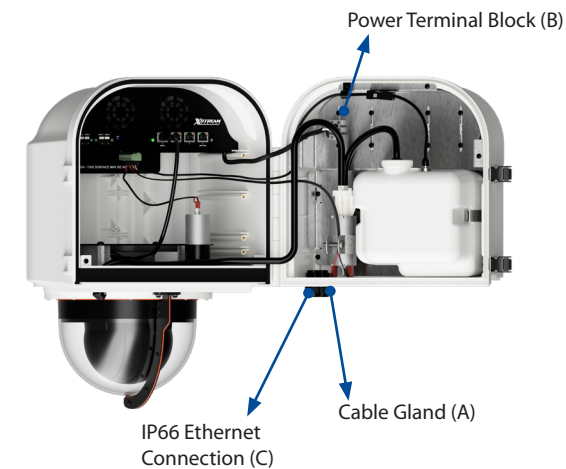

Figure 19 - Power & Network Connections

15. Loosen the black cable gland (A) and feed the power cable through and tighten to seal the egress (Figure 19).

16. Connect the appropriate power to the power terminal block (B) (Figure 19).

17. Using the IP66 Ethernet Parts that came with the enclosure, terminate the network cable and connect to the IP66 Ethernet Connection (C) (Figure 19).

18. Refer to the X|Clear User Manual for instructions regarding the accessory power and ethernet PoE ports and proper wiring practices.

19. Carefully align the front housing to the rear housing, close the enclosure and secure the latches.

Note: Please refer to the X|Smart software manual for additional setup instructions and remotely controlling the enclosure system.

15